



2026

QX80



↓ SWIPE

Jump to a Section

Tap an arrow to skip to section

Design

Exterior, Interior, SPORT,
Space & Cargo



Onboard Tech

Klipsch® Audio System, Infotainment,
Personalization Tech



Drive Tech & Performance

Driver Assist Technology, Performance



Style & Specs

Style, Specs, Trims



Accessories

Exterior, Interior, Cargo, Towing,
Lighting & Tech, Pet



Design

Exterior



Interior



SPORT



Space & Cargo



Back to Menu



Build & Price →

2026 QX80

An Invitation To Share



BACK TO SECTION

2026 QX80

The journey is the reward, and sharing it with others makes it all the more meaningful. The 2026 INFINITI QX80 is your space to savor life's in-between moments in luxurious comfort and sophisticated style, turning them into lasting memories with whomever you invite along for the ride.

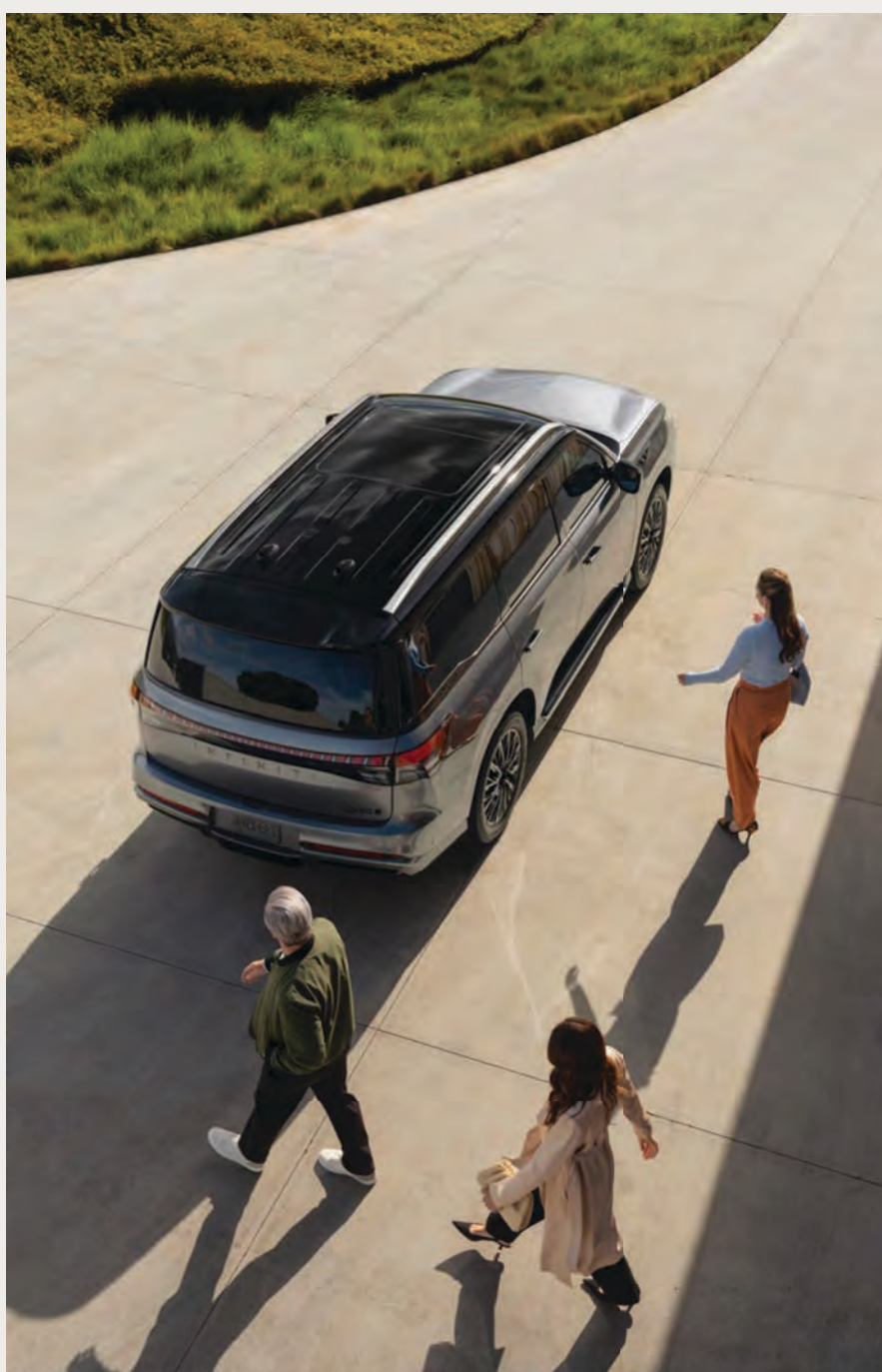

2026 QX80

As you approach QX80, the **INFINITI Light Path**¹ illuminates your walkway to invite you closer, while the **approach unlock & walk away lock** feature senses your presence and unlocks the doors for you. At the same time, the **flush door handles** extend in greeting. Altogether, it's an embodied experience of hospitality.

INFINITI Light Path¹

Flush door handles

FRONT DESIGN CUES

Elegance That Draws Guests In



FRONT DESIGN CUES

Lead from the front with the impressive Piano Black **waterfall grille**, inspired by the Kyoto bamboo forest and featuring an **INFINITI Radiant® Illuminated Grille Emblem**. Together with the graceful dance of the **Digital Piano Key signature lighting**, QX80 draws the eye in and down the infinite road, luminously intersecting the distant horizon.



Waterfall grille



INFINITI Radiant® Illuminated Grille Emblem

FRONT DESIGN CUES

Complemented by its **wide stance** and available **22-inch aluminum-alloy wheels**, the QX80 projects a bold, quiet confidence that draws attention without ever calling for it.



22-inch AUTOGRAPH aluminum-alloy wheels¹



REAR DESIGN CUES

Style That Turns
Its Back on No One



REAR DESIGN CUES

Make an exit worthy of your entrance – impressive yet boastless. The **light curtain rear taillights**, complemented by the **Digital Piano Key lighting**, dazzle onlookers as more than 300 micro-LED lights illuminate the entire width of the QX80 to create an effortlessly spectacular finish.



Light curtain rear taillights

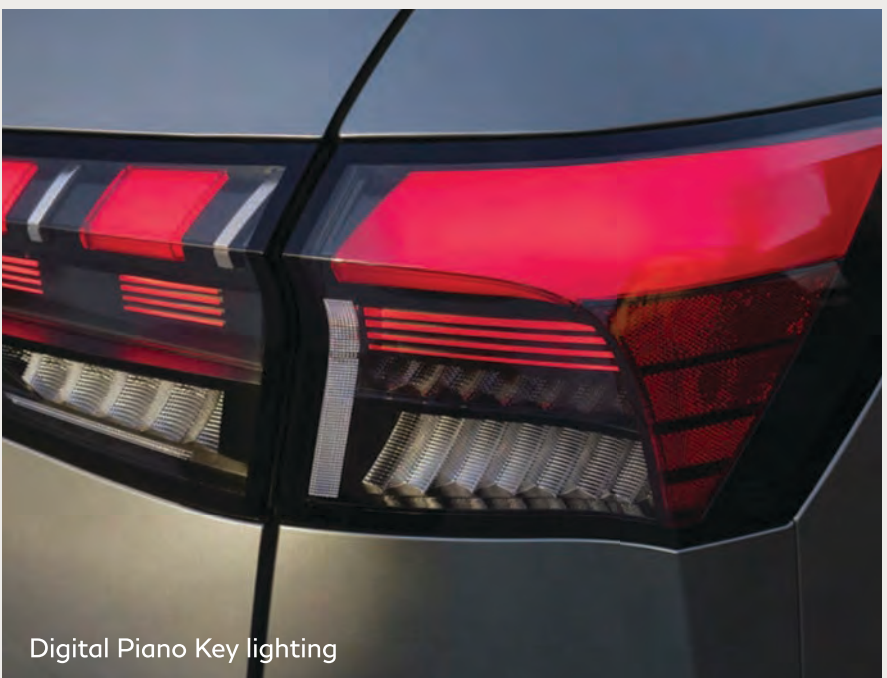

Digital Piano Key lighting

REAR DESIGN CUES

As you depart, onlookers will notice how the windows and **"floating" roofline** gracefully melt into one another to form a sleek, fluid profile and wonder where the journey will take you and your companions next.



"Floating" roofline

QX80

Interior



PREMIUM INTERIOR

Savor the Sensation¹



PREMIUM INTERIOR

Success is a shared endeavor, and the QX80 invites those who have helped you get there to revel in it – with first-class seating in every row and available 12-way power front seats.



PREMIUM INTERIOR

With available **semi-aniline leather-appointed seats**, captain's chairs in the first two rows and an available **Rear Control Panel** with touch-screen functionality, you can extend premium comfort – and control – to you and your guests.



Semi-aniline leather-appointed seats¹



Rear Control Panel¹

QX80

Interior



SEATING

Room for Life



SEATING

Design your QX80 around your hosting needs, with a choice to **seat either seven or eight passengers**. The seven-seater allows your second-row guests to luxuriate in their very own captain's chairs. Or, opt for the eight-seat configuration, available on the PURE and LUXE, to maximize your hosting potential with bench seats in the second and third rows.



Second-row captain's chairs



Third-row bench seat

QX80

Interior

DESIGN INTRICACIES

A World of Detail



DESIGN INTRICACIES

It takes a trained eye to properly notice the subtle inspirations of true craftsmanship, though all will immediately feel its powerful effects. The **key fob's ridged pattern** is inspired by the summer kimono design worn by the samurai. The available **Open Pore Ash Wood with Metal Inlay interior trim**, fashioned after the silver strings of a traditional koto instrument, creates unique reflectivity depending on the angle of the light. These details are both inspired and inspiring.



Open Pore Ash Wood with Metal Inlay interior trim¹

DESIGN INTRICACIES

The available **diamond pattern** on the captain's chairs features perforations with dot-quilting to create a subtle pillowing effect. Rather than abruptly ending, the pattern gently fades as it reaches the edge of the seat. Similar in subtlety, the available **luxurious wrapped interior panels** are hand-stretched and fitted to elevate what would otherwise be ordinary. It's a detail that requires the delicate touch of a skilled artisan.

Diamond-pattern dot-quilting¹Luxurious wrapped interior panels¹

QX80

SPORT

SPORT

Undeniable
Presence



EXTERIOR EXPRESSION

Make a more striking impression with the new-for-2026 QX80 SPORT. The SPORT refines the **front fascia and grille** with a **unique front bumper**, while unique **SPORT 22-inch wheels** enhance the vehicle's bold profile. **Black roof rails² and mirror caps** add a sleek look, and the **dark chrome exterior trim** imbues an extra touch of sophistication. Altogether, it's an exterior that radiates dynamic elegance.



Unique SPORT front fascia and grille



22-inch unique SPORT aluminum-alloy wheels and black roof rails²

INTERIOR EXPRESSION

Indulge your senses further with the sophisticated interior of the new QX80 SPORT. Unique **Dusk Blue Semi-aniline Leather-appointed seating** offers both comfort and a contemporary burst of color, and the **graphite headliner and pillars** add to the cabin's sleek, refined atmosphere. High-level craftsmanship and stylish details transform your every journey into an exquisite experience.

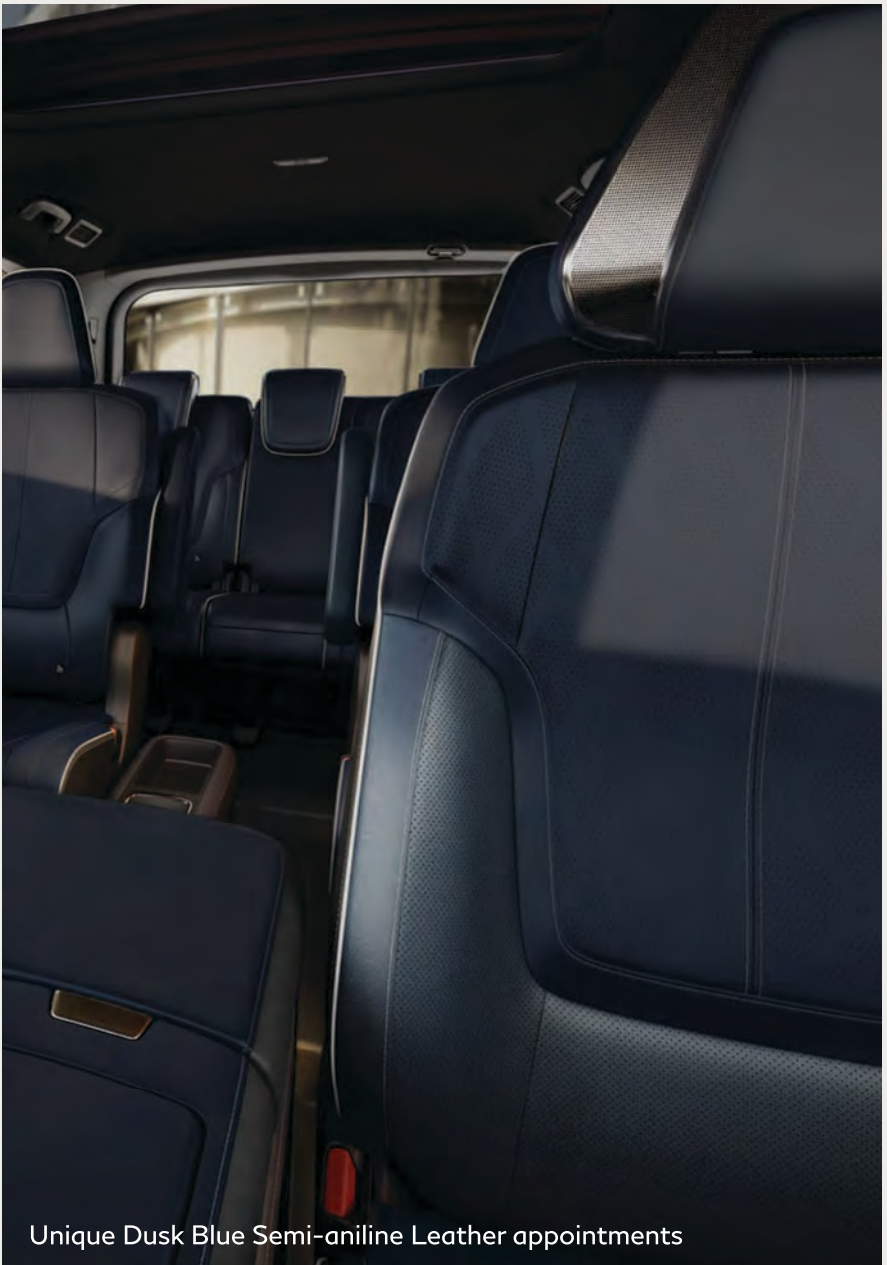

Unique Dusk Blue Semi-aniline Leather appointments

CARGO CONFIGURATIONS

Reconfiguration-Ready



CARGO CONFIGURATIONS

Life is filled with shifting needs, and QX80 can adapt to yours at a moment's notice. When your hands are full, the **Motion-Activated Liftgate** allows you to easily access the **97.1 cu. ft. of cargo room** created with the second- and third-row seats folded down without lifting a finger.²



Power 60:40-split third-row seats folded down

CARGO CONFIGURATIONS

Conveniently access the available **remote control rear seats** via the front-row center touch-screen display or from the cargo area. Raise or lower the second-row captain's chairs and third-row bench seats in various configurations to suit your cargo needs.^{2,3,4}



Onboard Tech

- Klipsch® Audio System 

- Infotainment 

- Personalization Tech 

- Back to Menu 

Build & Price →

QX80

Klipsch® Audio System



KLIPSCH® REFERENCE PREMIERE

High Fidelity



BACK TO SECTION

QX80

Klipsch® Audio System

KLIPSCH® REFERENCE PREMIERE

Klipsch® takes its premium sound system on the road. More akin to a concert hall than an SUV, the **24 high-performance speakers** of the available Klipsch® Reference Premiere Audio System evenly distribute an **immersive 3D surround sound** experience, while **DynamicAudioReveal®** technology helps bring out the emotion and clarity of every note.¹



Klipsch® Reference Premiere Audio System with 24 speakers¹

QX80

Klipsch® Audio System

KLIPSCH® REFERENCE PREMIERE

When a call comes in, the music doesn't have to go out. **Individual Audio** directs sound through speakers in the driver's headrest, allowing the driver to converse while the passengers enjoy the music. **Advanced directional microphones** pick up only the driver's voice, ensuring a clean call where no one is interrupted.^{1,5,6}

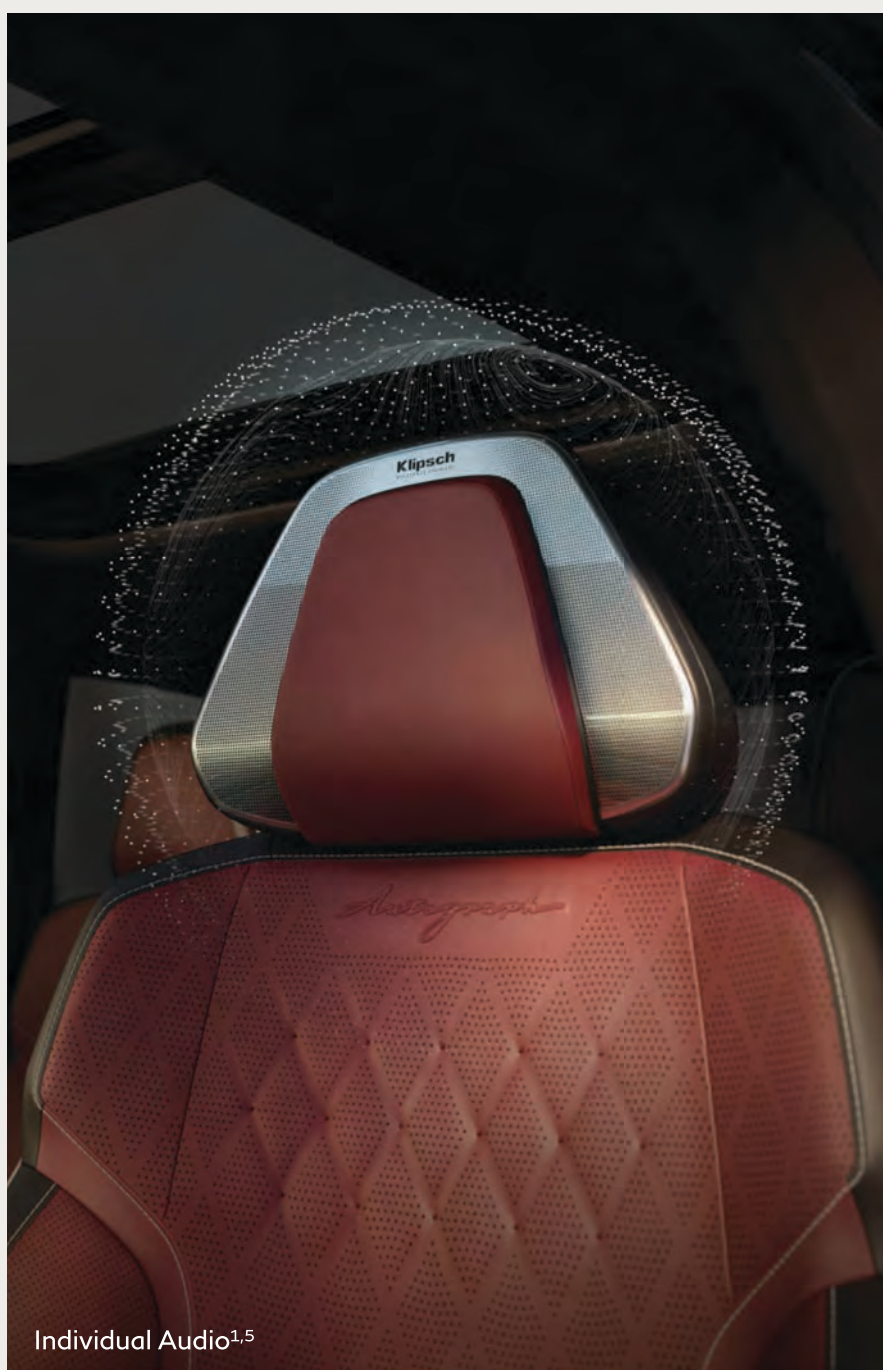

Individual Audio^{1,5}

QX80

Infotainment

INTUITIVE DISPLAYS

Life on Full Display



INTUITIVE DISPLAYS

Harmonize the serenity of what's outside with the comfort of what's inside. Showcased on **dual 14.3" displays**, the intuitive **Live Wallpaper** instinctively adapts to the time of day, while the available **Personalized Ambient Lighting** features 64 unique color selections that can be adjusted to reflect the current season.^{4,7} When it's numbers you need, the available **Head-Up Display** projects pertinent information, like speed limits and turn-by-turn navigation, directly onto the windshield.^{8,9,10}



Live Wallpaper

A/C AUTO

INTUITIVE DISPLAYS

Have eyes on what matters. The available **INFINITI Dash Cam Recorder** captures front and rear exterior footage for added peace of mind. Standard on the AUTOGRAPH trim, the **in-car camera** allows you to view the interior on the center screen and zoom into rear rows to record special rear-seat moments that can be shared with friends and family. Left something behind? Simply access the camera via the INFINITI Dash Cam Recorder app on your smartphone to check for forgotten items.^{1,6,11,12}



QX80

Infotainment



GOOGLE BUILT-IN

Your World,
With You



GOOGLE BUILT-IN

Your INFINITI with **Google built-in** becomes a natural extension of your smartphone. Simply log in with your existing Google Account to access your favorite apps, including maps, music and more. And with intuitive voice control, adjusting the climate control, setting your navigation and responding to messages are all a simple "Hey Google" away.^{4,10,13,14}

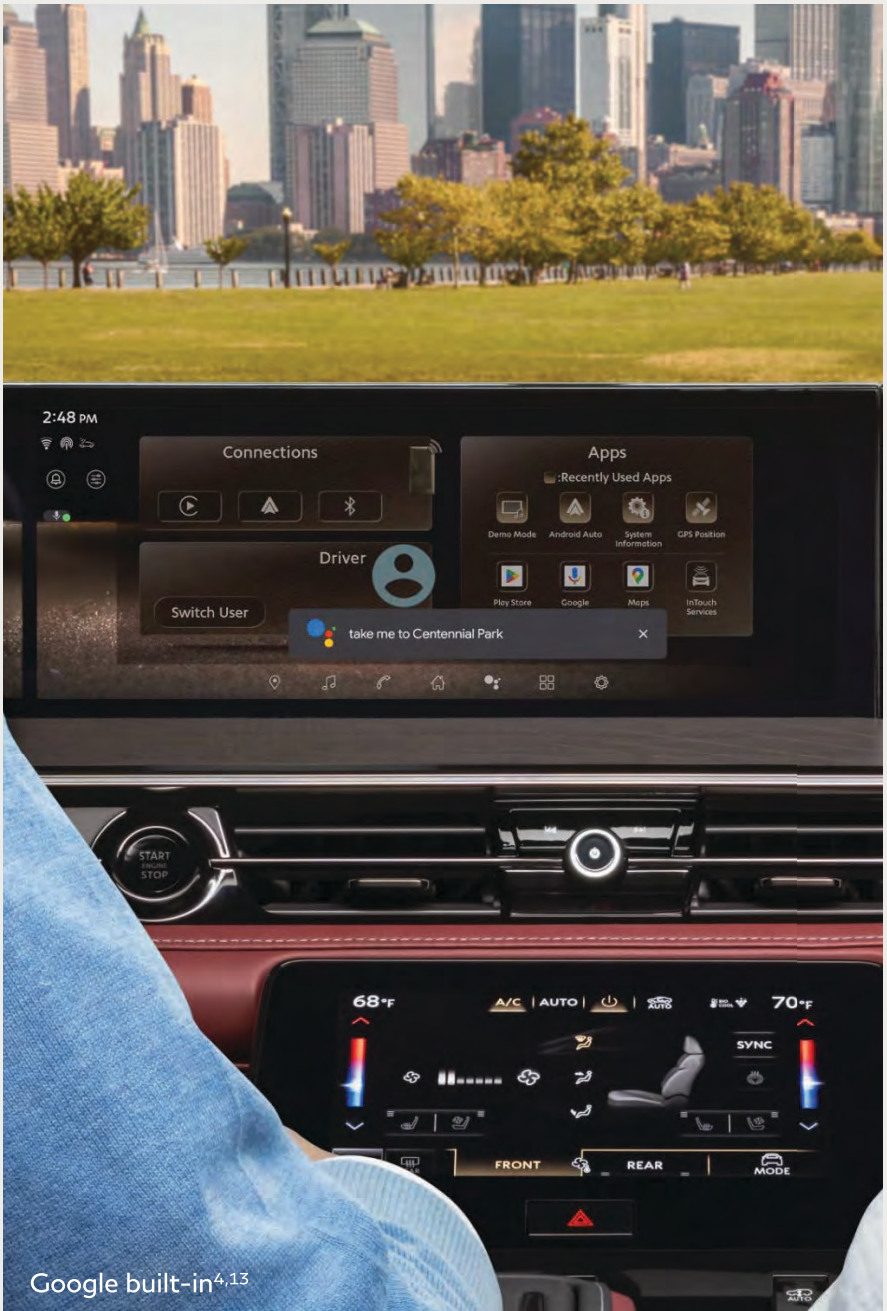

GOOGLE BUILT-IN

Just Ask Google

**GOOGLE ASSISTANT**

Bring Google into your QX80 and talk to Google Assistant for hands-free help in the car. Enjoy access to vehicle functions, such as turning on heated and ventilated seats and setting the climate control^{1,4,13}

**GOOGLE MAPS**

Your built-in navigation system that integrates across displays so you stay connected and up-to-date^{4,10,13}

**GOOGLE PLAY STORE**

Includes apps for music, video and messaging and can add new features and entertainment as they develop^{4,13,14}

CONNECTIVITY

Connection Is in the Air



CONNECTIVITY

Seamless iPhone® connectivity comes standard. With wireless **Apple CarPlay®** integration, QX80 becomes a natural extension of your compatible iPhone®, so you can listen to your messages, select a podcast, stream your music and more – all on the touch-screen display without dealing with cumbersome cables and messy wires.^{4,6,14}



CONNECTIVITY

With wireless **Android Auto™**, you can connect your compatible Android™ phone and access your favorite apps with no cords required. And when you need to charge, simply rest your compatible smartphone on the **wireless charging pad**.^{4,6}

Wireless Android Auto^{4,10}

QX80

Personalization Tech

CUTTING-EDGE COMFORT

Achieve Equilibrium



CUTTING-EDGE COMFORT

QX80 has guest comfort down to a science. If a first- or second-row passenger enters feeling too warm, available **Biometric Cooling** can detect their body temperature using infrared scanning and intuitively adjust the fan speed, creating thermal bliss – all without needing to push a button.¹⁵ Helping to reduce the effects of light, heat and ultraviolet and infrared rays are **UV and IR cut glass windows**. Even the air is carefully considered, as a cutting-edge **Plasmacluster® air purifier** and **Grape Polyphenol filter** cleanse the air of odors for a cabin that smells fresh.^{1,16}

Biometric Cooling^{1,15}

CUTTING-EDGE COMFORT

With available **heated seats in all three rows** and available **climate-controlled and massaging first- and second-row seats**, QX80 lets all your guests set and achieve their own standard of comfort. The available **Rear Control Panel** with touch-screen functionality makes accessing these options even more convenient. And with the available front **console cool box**, even small items like seltzer water and chocolate bars have a space to stay cool.



First- and second-row massaging seats¹



First- and second-row climate-controlled seats¹

QX80

Personalization Tech

WELCOMING CONVENIENCES

A Strong Start



WELCOMING CONVENIENCES

Set the tone for an empowered journey. The **Electronic Air Suspension** can automatically lower your QX80 when it's shifted into park, so you can step out and load or unload cargo more smoothly.^{1,2,17} Make your entrance more comfortable by preheating or precooling the cabin with **Remote Engine Start with Climate Control** on your compatible smart device.^{6,18,19}



Electronic Air Suspension^{1,17}

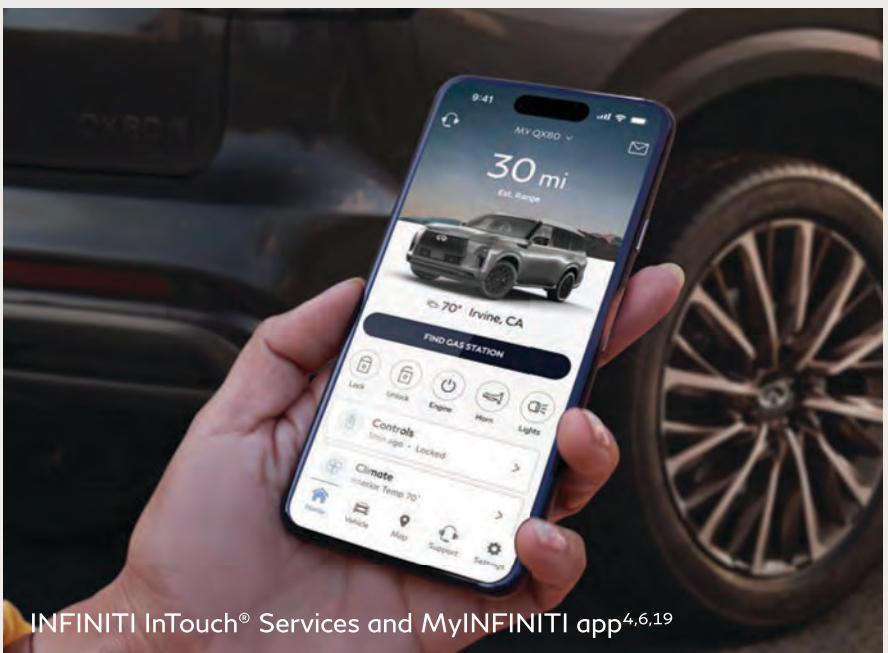

INFINITI InTouch® Services and MyINFINITI app^{4,6,19}

Drive Tech & Performance

Driver Assist Technology



Performance



Back to Menu



Explore Tech Features → 

Build & Price →

QX80

Driver Assist Technology



DRIVER ASSIST FEATURES

Comfortable Control



BACK TO SECTION

DRIVER ASSIST FEATURES

Reimagine the relationship between driver and vehicle. When activated, standard **ProPILOT Assist 1.1** with **Steering Assist** can maintain your set speed and assist the driver in helping keep the vehicle centered within the traveling lane. In traffic, **Intelligent Cruise Control** maintains your distance and brakes when traffic slows – even coming to a complete stop – before re-accelerating when it clears.²⁰



DRIVER ASSIST FEATURES

Achieve control in unexpected ways. Available **ProPILOT Assist 2.1**, standard on the AUTOGRAPH trim, can gently assist you into an adjacent open lane and then accelerate to your desired speed. From there, you're free to loosen up as **hands-off driving** helps keep you centered in your lane.²¹



QX80

Driver Assist Technology



VISIBILITY FEATURES

Optical Solutions



VISIBILITY FEATURES

The available **Smart RearView Mirror** does more than reflect what's behind you. When your QX80 is full of guests or cargo, simply flip a switch to transform your rearview mirror into a monitor that shows the view from the rear cargo door-mounted camera – for unobstructed visibility.^{2,20}

Smart RearView Mirror^{1,20}

VISIBILITY FEATURES

See through space and time, in full view, on dual 14.3" displays.^{4,7} The near-**180-degree Front Wide View camera** shows you what's around the corner without needing to pull forward. Or, if you need to see what's under you, the **Invisible Hood View** projects an image of what's directly in front of the QX80 to spot the curb, the track at the car wash or a runaway soccer ball.²⁰



Near-180-degree Front Wide View²⁰



Invisible Hood View²⁰

QX80

Driver Assist Technology



MANEUVERABILITY FEATURES

Wield With Grace



MANEUVERABILITY FEATURES

A commanding presence should mean expansion, not limitation. When you need to gauge your clearance, the **3D Around View® Monitor with Moving Object Detection** gives you eight exterior views of QX80 in one image. Then, with the single push of a button, watch as the camera rotates 360 degrees around the vehicle for a quick view of your surroundings. As you maneuver, the system alerts you to motion detected around the vehicle.^{20,22}



3D Around View® Monitor with Moving Object Detection²⁰

ADDITIONAL DRIVER ASSIST FEATURES

Gentle Guidance for the Road Ahead

**PREDICTIVE FORWARD COLLISION WARNING**

Can alert you to a potential collision up to two cars ahead²⁰

**FORWARD EMERGENCY BRAKING WITH PEDESTRIAN DETECTION**

Helps watch for vehicles and pedestrians in your path, and if detected, can apply the brakes²⁰

**LANE DEPARTURE PREVENTION**

Constantly monitors lane markings and can help guide you back if you unintentionally begin to drift²⁰

**BLIND SPOT INTERVENTION®**

Helps alert the driver to vehicles detected in the blind spot area and actively assists you back toward the center of your lane²⁰

**REAR CROSS TRAFFIC ALERT**

Uses sensors when backing up to detect approaching vehicles from either side and alerts the driver²⁰

**REAR AUTOMATIC BRAKING**

Can help apply the brakes if large stationary objects are detected behind you²⁰

QX80

Performance



DYNAMIC DIGITAL SUSPENSION

Go Smoothly



DYNAMIC DIGITAL SUSPENSION

QX80 is designed to deliver a smoother ride for everyone on board, regardless of the road. Designed to help minimize noise, fatigue and motion sickness in certain driving conditions, the **Dynamic Digital Suspension** works with the **Electronic Air Suspension** to intelligently regulate vehicle body behavior, so even life's twists and turns can be navigated in security and comfort. They also lower the vehicle at cruising speeds for enhanced control and aerodynamics, optimizing for both efficiency and performance.^{1,17,23}



QX80

Performance

PERFORMANCE CAPABILITIES

Empowered and Empowering



PERFORMANCE CAPABILITIES

Power produces both the confidence and the means you need to get there, and QX80 redefines what's possible. The **3.5-liter twin-turbocharged V6 engine** generates up to **450 hp** and **516 lb-ft of torque**, with up to **8,500 lbs towing capacity**, for a journey empowered from start to finish.²⁴ Traverse intrepidly as **INFINITI All-Mode 4WD®** can automatically adapt to differing road surfaces and driving conditions, or choose the support you need with the **Drive Mode Selector**.^{1,25} And the **9-speed automatic transmission with paddle shifters** liberates you to pursue the road ahead in calm control.



3.5-liter twin-turbocharged V6 engine

Style & Specs

Style



Specs



Trims



Back to Menu



Build & Price →



Anthracite Gray*



Mineral Black**,**



Coulis Red**,**



Radiant White**,**



Grand Blue**,**



Dynamic Metal**,**



Black Obsidian

INFINITI has taken care to ensure that the digital color swatches presented here are the closest possible representation of actual vehicle colors. Swatches may vary slightly due to viewing light or screen quality. Please see the actual vehicle and colors at your retailer. *Extra cost option. **Two-tone exterior paint is only available on SPORT and AUTOGRAPH trims.

INTERIORS 1 OF 3



Graphite TailorFit® (PURE)



Tuscan Beige TailorFit® (PURE)



Graphite Leather appointments (LUXE)

INTERIORS 2 OF 3



Sepia Brown Leather appointments (LUXE)



Dusk Blue Semi-aniline Leather appointments (SPORT)



Graphite Semi-aniline Leather appointments (AUTOGRAPH)

INTERIORS 3 OF 3

Burgundy Semi-aniline Leather appointments (AUTOGRAPH)

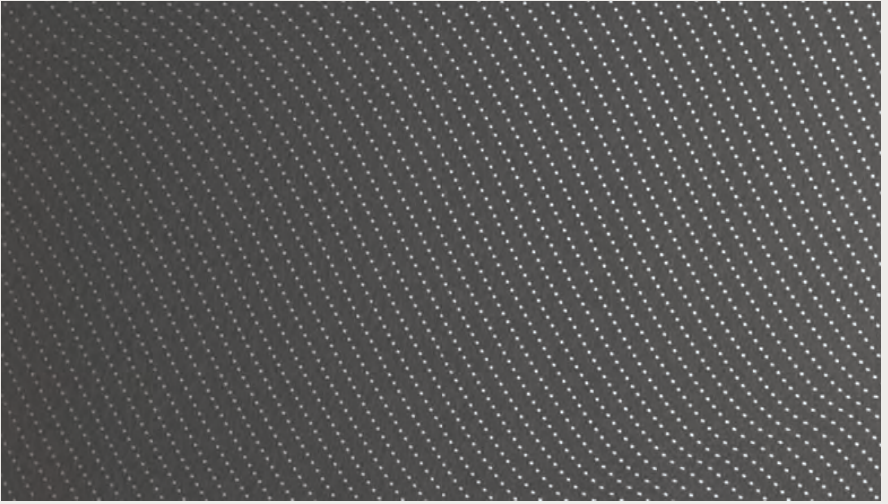

Black Aluminum (PURE / LUXE)



Open Pore Ash Wood (SPORT)

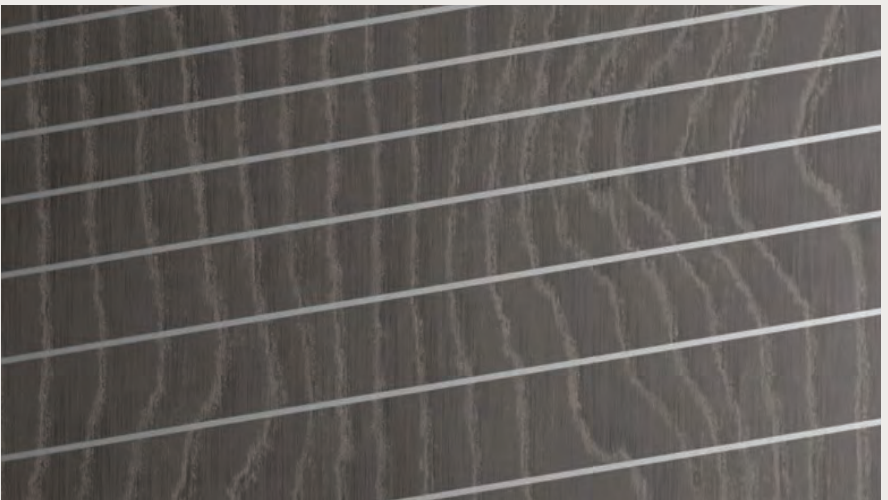

Open Pore Ash Wood with Metal Inlay (AUTOGRAPH)



20-inch aluminum-alloy wheels (PURE)



22-inch aluminum-alloy wheels (LUXE)



22-inch aluminum-alloy wheels (SPORT)



22-inch aluminum-alloy wheels (AUTOGRAPH)

INTERIOR DIMENSIONS

Head room – first row / second row / third row (inches)
39.1 / 37.8 / 36.2

Leg room – first row / second row / third row (inches)
43.8 / 39.2 / 32.9

CAPACITIES

Seating
7 or 8 passengers

Cargo volume² – 2nd and 3rd row folded flat
97.1 (cu. ft.)

Maximum tow capacity²⁴
8,500 lbs

Fuel tank
23.6 gallons

POWER & FUEL ECONOMY

Horsepower

450 hp @ 5,600 rpm

Torque

516 lb-ft @ 3,600 rpm

Estimated fuel economy 2WD²³ – city / highway /
combined (MPG)

16 / 20 / 18

Estimated fuel economy 4WD²³ – city / highway /
combined (MPG)

16 / 19 / 17

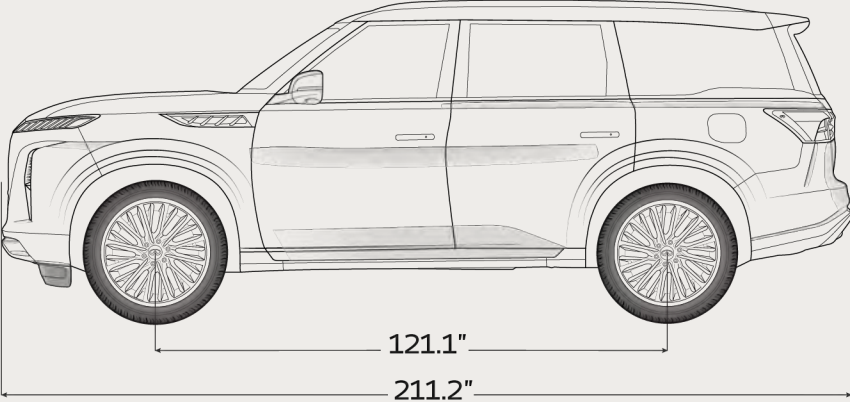
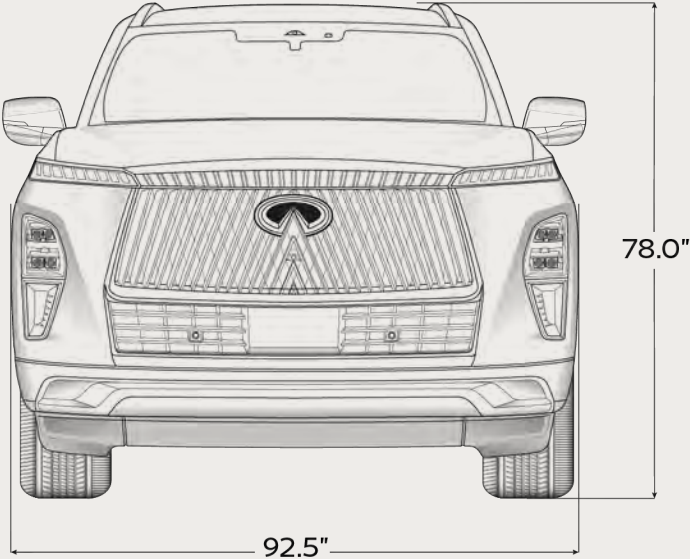

All dimensions are measured in inches.



QX80 PURE

Elegant Hospitality for All



QX80 LUXE

Additional Comfort and Convenience Features



QX80 SPORT

Exclusive Exterior and Interior Accents



QX80 AUTOGRAPH

For the Consummate Host



QX80

PURE



Build & Price →



PURE 1 OF 7**MECHANICAL & PERFORMANCE**

3.5L twin-turbo V6 engine (450 hp, 516 lb-ft of torque)

9-speed automatic transmission with manual shift mode

Paddle shifters

Rear-Wheel Drive or INFINITI All-Mode 4WD^{®25}

Drive Mode Selector

13.78-inch front/rear ventilated disc brakes

Independent double-wishbone front/rear suspension

Electric power steering

Integrated Class IV tow hitch and 7-pin wiring harness²⁴

EXTERIOR

20-inch aluminum-alloy wheels with 275/60R20 all-season tires

LED automatic on/off headlights

LED signature Daytime Running Lights

INFINITI Radiant[®] Illuminated Grille Emblem

PURE 2 OF 7

Panoramic moonroof

Acoustic laminated glass (windshield and front side)

UV and IR cut glass (side and rear windows)

Rear privacy glass

Power folding, heated outside mirrors with integrated turn signals, puddle lamps and reverse sync

Auto-dimming driver-side outside mirror

Flush door handles

Silver roof rails²

Body-color running boards

COMFORT & CONVENIENCE

TailorFit[®] seats

Leather-wrapped steering wheel

Black Aluminum interior trim accents

10-way power front seats, including 2-way lumbar support

Second-row captain's chairs with manual slide and recline^{26,32}

PURE 3 OF 7

Third-row 60:40-split fold-down bench seat with power recline and one-touch folding²⁶

Power tilting and telescoping steering column

2-driver memory system for driver's seat, steering wheel and outside mirrors

Tri-Zone Automatic Temperature Control System with microfilter

Heated first- and second-row seats

Heated steering wheel

Intelligent Key with push button ignition

Remote Engine Start¹⁸

Approach unlock & walk away lock

Trailer light check²⁴

Frameless auto-dimming rearview mirror

Rain-sensing front windshield wipers

Motion-Activated Liftgate

INFOTAINMENT

INFINITI 14.3-inch Dynamic Meter Display⁷

INFINITI InTouch® 14.3-inch Interactive Display⁴

PURE 4 OF 7

9-inch front touch-screen control panel with haptic feedback

INFINITI InTouch® Services with 5-year trial access to Select and 3-year trial access to Premium packages⁴

In-Vehicle Data and 5G Wi-Fi^{4,27}

Google built-in^{4,13}

Wireless Apple CarPlay® integration⁴

Wireless Android Auto compatibility⁴

Bluetooth® Hands-free Phone System with audio streaming⁴

Connected garage door opener with myQ®

SiriusXM® with 360L with 3-month subscription included²⁸

Klipsch® Premium Audio System with 14 speakers

Active Sound Enhancement

8 USB-C ports⁶

Wireless charging pad⁶

PURE 5 OF 7**DRIVER ASSISTANCE**

ProPILOT Assist 1.1 featuring Intelligent Cruise Control with full-speed range, stop & hold and auto-resume, and Steering Assist²⁰

Predictive Forward Collision Warning²⁰

Forward Emergency Braking with Pedestrian Detection²⁰

Lane Departure Warning²⁰

Lane Departure Prevention²⁰

Blind Spot Warning²⁰

Blind Spot Intervention^{®20}

Rear Cross Traffic Alert²⁰

Rear Automatic Braking²⁰

Front and Rear Sonar System²⁰

3D Around View[®] Monitor with Moving Object Detection²⁰

Hill start assist

Trailer sway control²⁴

Electronic parking brake with Auto Hold

PURE 6 OF 7

High Beam Assist

Traffic Sign Recognition⁹

Driver Attention Alert²⁰

SAFETY

INFINITI Advanced Air Bag System includes dual-stage front air bags with seat belt sensors and an occupant-classification sensor²⁹

Driver and front-passenger supplemental knee air bags²⁹

Driver and front-passenger seat-mounted side-impact supplemental air bags²⁹

Roof-mounted curtain supplemental air bags for side-impact and rollover head protection for outboard occupants²⁹

LATCH System (Lower Anchors and Tethers for Children)

Zone Body construction with front and rear crumple zones

Tire Pressure Monitoring System with Easy-Fill Tire Alert^{30,31}

PURE 7 OF 7**AVAILABLE OPTION 1****1 SPLIT-BENCH SEAT PACKAGE**

Second-row 40:20:40-split folding bench seat

Center armrest with two cup holders
(replaces second-row captain's chairs)

QX80

LUXE



Build & Price →



LUXE 1 OF 2

Includes All QX80 PURE Standard Features, Plus:

MECHANICAL & PERFORMANCE

Electronic Air Suspension¹⁷

Dynamic Digital Suspension

EXTERIOR

22-inch aluminum-alloy wheels with 275/50R22 all-season tires

COMFORT & CONVENIENCE

Leather-appointed seats (first and second rows)

12-way power front seats, including 4-way lumbar support

Second-row power slide/recline seats with power seat remote control and with one-touch easy third-row entry/exit^{26,32}

Climate-controlled first- and second-row seats

INFOTAINMENT

Head-Up Display⁸

LUXE 2 OF 2**AVAILABLE OPTIONS** **1** **2****1 SPLIT-BENCH SEAT PACKAGE**

Second-row 40:20:40-split folding bench seat

Center armrest with two cup holders
(replaces second-row captain's chairs)

2 INFINITI RADIANT® ILLUMINATED KICK PLATES

INFINITI Radiant® Illuminated Kick Plates for front and rear doors

QX80

SPORT



Build & Price →



SPORT 1 OF 2

Includes All QX80 LUXE Standard Features, Plus:
MECHANICAL & PERFORMANCE

INFINITI All-Mode 4WD^{®25}

EXTERIOR

22-inch SPORT aluminum-alloy wheels with
275/50R22 all-season tires

INFINITI Light Path

Auto-dimming passenger-side outside mirror

Unique SPORT front grille

Unique SPORT front bumper

Black roof rails² and mirror caps

Dark chrome exterior trim

Unique SPORT "S" badge on liftgate

COMFORT & CONVENIENCE

Unique Dusk Blue Semi-aniline Leather-appointed
seats (first and second rows)

Premium leather-wrapped steering wheel

Open Pore Ash Wood interior trim accents

Smart RearView Mirror²⁰

SPORT 2 OF 2

Graphite headliner and pillars

Personalized Ambient Lighting (64-color)

INFINITI Radiant® Illuminated Kick Plates

Dual occupant memory system for front-passenger's seat

Advanced Climate Control System with auto-recirculation, Plasmacluster® air purifier and Grape Polyphenol filter¹⁶

Biometric Cooling¹⁵

Massaging front seats

120-volt AC power outlet in cargo area³³

HomeLink® Universal Garage Door Opener

INFOTAINMENT

INFINITI Dash Cam Recorder¹¹

Klipsch® Reference Premiere Audio System with 24 speakers

DJX® 3D Surround technology

DynamicAudioReveal® noise compensation

Individual Audio⁵

QX80

AUTOGRAPH



Build & Price →



AUTOGRAPH 1 OF 2

Includes All QX80 SPORT Standard Features, Plus:

EXTERIOR

22-inch AUTOGRAPH aluminum-alloy wheels with 275/50R22 all-season tires

Silver roof rails²

COMFORT & CONVENIENCE

Dot-quilted semi-aniline leather-appointed seats

Open Pore Ash Wood with Metal Inlay interior trim accents

Graphite suede headliner and pillars

Second-row massaging seats with 4-way power lumbar support

Heated third-row seats

Front console cool box

Heated wiper pack

AUTOGRAPH 2 OF 2**INFOTAINMENT**

In-car camera with remote view¹²

9-inch rear touch-screen control panel

INFINITI InTouch® Services with 3-year trial access to ProPILOT Assist 2.1^{4,21}

DRIVER ASSISTANCE

ProPILOT Assist 2.1 featuring Lane Change Assist, Passing Assist and hands-off driving^{20, 21}

SAFETY

Driver seat-mounted front-center supplemental air bag²⁹

Accessories

Exterior



Interior



Cargo



Towing



Lighting & Tech



Pet



Back to Menu



Build & Price →

QX80

Exterior Accessories



EXTERIOR ACCESSORIES

Refine Your
Presence



EXTERIOR ACCESSORIES

Refine your presence with the **22" INFINITI Performance Monogram Wheel**, available in Black or Machined Finish, so you can roll in style. The transparent design of the **Clear Hood Protector** provides protection without sacrificing style.



22" INFINITI Performance Black Monogram Wheel



Clear Hood Protector

EXTERIOR ACCESSORIES

Protect your bumper from dings and scratches while enhancing the appearance of your QX80 with a **Rear Bumper Protector** (shown in Silver; also available in Dark Matte). The **Roof Rail Crossbars**, available in new Black or Silver finishes, integrate with various Affiliated: Yakima® roof rack accessories to maximize your vehicle's utility.^{2,3,4}



Silver Rear Bumper Protector

Silver Roof Rail Crossbars²

INTERIOR ACCESSORIES

Prepared for the
Everyday and
the Unexpected

QX80



BACK TO SECTION

INTERIOR ACCESSORIES

All-Season Floor Mats - High Wall Liners are custom-made of a durable and long-wearing material to help keep your QX80 clear of mud, slush and debris. The **Umbrella Holder** mounts under the front of the driver's or passenger's seat for convenient access to your **INFINITI Performance Compact Umbrella**, while the **Console Net** provides a versatile, lightweight solution for securing your everyday items.

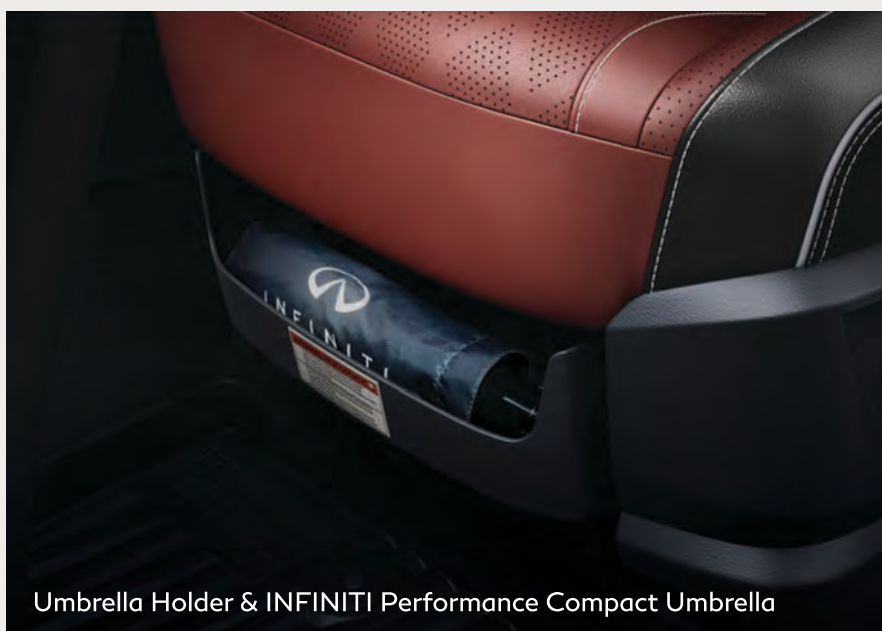

Umbrella Holder & INFINITI Performance Compact Umbrella

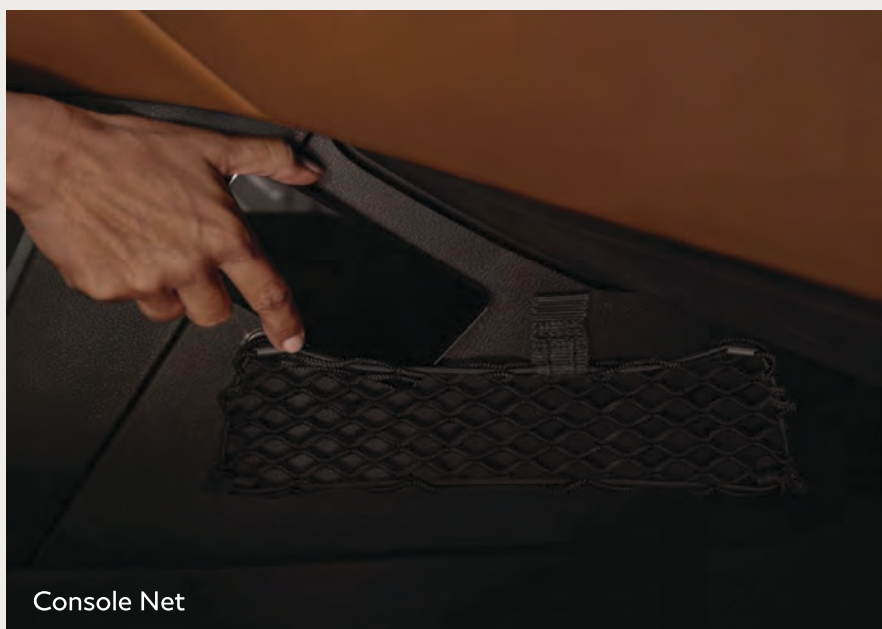

Console Net

INTERIOR ACCESSORIES

Take your organization further with a **Seatback Organizer** designed to fit over the back of the front-passenger's seat. Keep your QX80 clean and kempt with a **Trash Bin** featuring a stylish design that complements your vehicle's interior.



Seatback Organizer



Trash Bin

QX80

Cargo Accessories

CARGO ACCESSORIES

Excursion Awaits



CARGO ACCESSORIES

The **Cargo Net** helps keep your items from shifting while you're driving. Flex your flexibility with a **Cargo Shelf/Barrier**, which functions as a luggage board when positioned horizontally or as a cargo area barrier when positioned vertically. Add a **Soft Sided Cargo Cooler** to help keep your food and drinks cool for up to 30 hours on your next outing with its insulated, leakproof interior and sleek carbon fiber-patterned vinyl exterior.

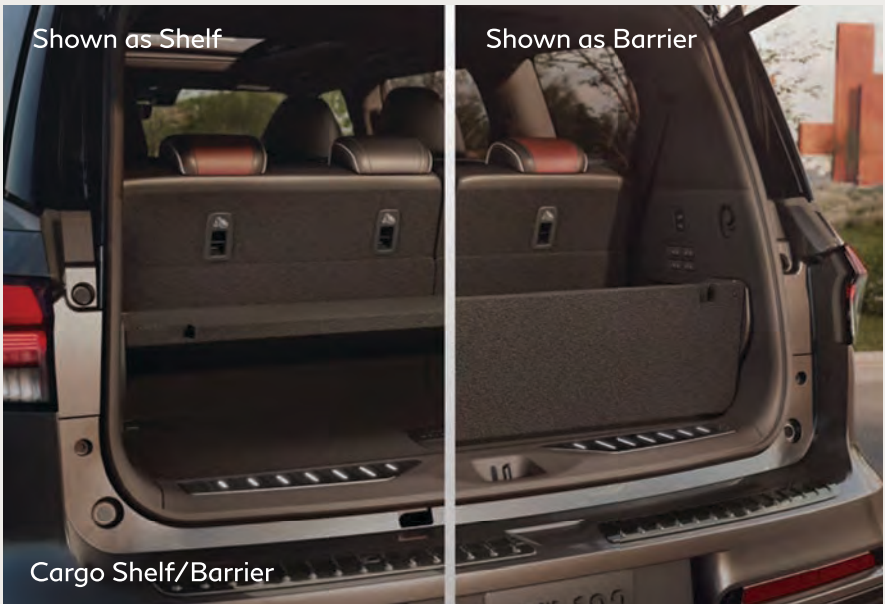

CARGO ACCESSORIES

Keep items secure with a set of interlocking **Cargo Blocks/Stabilizers**, which can securely connect to the **Carpeted Cargo Area Protector** to hold various sizes of cargo in place. And when your roaming takes you far, a **Hatch Tent (10' x 10')** converts your cargo area into a sleeping area.



Cargo Blocks/Stabilizers and Carpeted Cargo Area Protector



Hatch Tent (10' x 10')

CARGO ACCESSORIES

Haul your gear smoothly and in style with the **Affiliated: Yakima® SkyBox – Roof Cargo Box**, featuring a sleek, aerodynamic Carbonite textured lid and a dual-sided opening for easy access on either side of your vehicle. Visiting the mountains? The **Affiliated: Yakima® HitchSki – Hitch Mount Ski Adapter** holds and locks up to six pairs of snow skis or four snowboards with soft, flexible rubber padding to protect gear.^{2,34}



Affiliated: Yakima® SkyBox – Roof Cargo Box^{2,34}



Affiliated: Yakima® HitchSki – Hitch Mount Ski Adapter^{2,34}

QX80

Towing Accessories

TOWING ACCESSORIES

Possibility in Tow



TOWING ACCESSORIES

Go big on what you can bring. With a **Hitch Ball Mount - Class III** and **Hitch Ball - Class III (2" Coupler)**, QX80 is ready to tow your toys.²⁴



Hitch Ball Mount - Class III and Hitch Ball - Class III (2" Coupler)²⁴

QX80 Lighting & Tech Accessories



LIGHTING & TECH ACCESSORIES

That Futuristic
Feeling



QX80 Lighting & Tech Accessories

LIGHTING & TECH ACCESSORIES

The **Dual Camera Drive Recorder** points forward to capture what is in front of the vehicle and points to the inside to capture what happens in the cabin.¹² Available in Dark for SPORT and AUTOGRAPH or Silver for PURE and LUXE, **INFINITI Radiant® Illuminated Cargo Scuff Plates** are designed to help protect against scratches and scuffs when loading cargo while also enhancing your style. The **Rear Camera Dryer** operates automatically when using reverse gear to help keep the rear camera free from water drops.



INFINITI Radiant® Dark Illuminated Cargo Scuff Plates



Rear Camera Dryer

QX80 Lighting & Tech Accessories

LIGHTING & TECH ACCESSORIES

Cultivate ambience with a **Panoramic Illuminated Headliner**, which uses hidden white LEDs to illuminate the headliner area around the panoramic moonroof for a mood with a little bit of magic. Add a touch of style to every entrance with a soft-glowing INFINITI logo along the bottom of all four door sills powered by the **INFINITI Radiant® Illuminated Kick Plates**.



Panoramic Illuminated Headliner



INFINITI Radiant® Illuminated Kick Plates

QX80 Lighting & Tech Accessories

LIGHTING & TECH ACCESSORIES

Step up the interior styling with the **Frameless Auto-Dimming Rearview Mirror w/ HomeLink®**, which can be programmed to open your garage door or turn on the light at the touch of a button and adds a sleek and modern look. When someone's device needs power, reach for a **USB Charging Cable Set**, complete with two USB-C to USB-C connectors and one USB-C to Lightning® connector.⁶



Frameless Auto-Dimming Rearview Mirror w/ HomeLink®



USB Charging Cable Set⁶

QX80

Pet Accessories



PET ACCESSORIES

Room for the
Whole Family



PET ACCESSORIES

Bring your furry friends along for the adventure. The telescoping **Pet Ramp** expands to 64 inches to help your pups get in and out of the vehicle, and the folding **Pet Carrier** includes three mesh doors (top, side and front) with zipper closures. Available in four sizes, from small to x-large, the **Dog Harness** includes a tether strap that secures the harness to a rear-seat buckle to help prevent your dog from exiting the side door when you open it.



Pet Carrier



Dog Harness



INFINITI PREMIUM CARE

Drive With Confidence

Keeping your INFINITI properly maintained keeps it thoroughly rewarding. That's why to help sustain confidence in your drive and to provide you with added peace of mind in a constantly changing world, each new 2026 INFINITI vehicle includes the INFINITI Premium Care maintenance program that provides up to 3 oil changes and 6 tire rotations for 36 months or vehicle's designated mileage period (whichever occurs first). Factory-trained technicians use Genuine INFINITI parts to ensure the utmost care, quality and performance. For more information, please visit your local retailer.³⁵





The Journey Begins

Build an INFINITI that's tailored to your taste and designed around your life.

Build Your QX80 →

JOIN OUR COMMUNITY



1 Feature availability varies by vehicle model year, model, trim level, packaging and options.

2 Cargo shown for display purposes only. Cargo and load capacity limited by weight and distribution. Always secure cargo. Heavy loading of the vehicle with cargo, especially on the roof, will affect the handling and stability of the vehicle.

3 When operating the rear power-seatback return, make sure that the vehicle is stopped and the transmission is in the P (Park) position.

4 See www.infiniti.com/intouch/legal for more INFINITI InTouch features/services information.

5 Available feature. Individual Audio is intended to isolate select audio sources for equipped seating positions, and cannot buffer interior sound. Before using, read Owner's Manual for further information.

6 Driving is serious business and requires your full attention. If you have to use the connected device while driving, exercise extreme caution at all times so full attention may be given to vehicle operation. External device not included.

7 Information displayed in image is dependent on how vehicle is equipped. Driving is serious business and requires your full attention. If you have to use the feature while driving, exercise extreme caution at all times so full attention may be given to vehicle operation.

8 Do not use for extended periods of time. See Owner's Manual for important safety information.

9 Traffic Sign Recognition may not detect and read all traffic signs in all conditions. Driver should monitor all traffic signs and obey all traffic laws. See Owner's Manual for details.

10 Never program while driving. GPS mapping may not be detailed in all areas or reflect current road status.

11 INFINITI Dash Cam Recorder to be used only in accordance with any laws or rules in effect in your vehicle's location that may apply to audio or video recordings of drivers and passengers. Not every impact will trigger the vehicle's sensors and, as a result, may not activate some or all the vehicle's cameras.

12 In-car camera and Dual Camera Drive Recorder to be used only in accordance with any laws or rules in effect in your vehicle's location that may apply to audio or video recordings of drivers and passengers.

13 Feature availability varies by vehicle model year, model, trim level, packaging and options. **Consumer activation of INFINITI InTouch Services SELECT package ("Package") required.** Package trial period included with eligible new vehicle purchase or lease. Trial period may be subject to change or termination at any time and without notice. After trial period ends, monthly subscription fee required. Driving is serious business and requires your full attention. Only use features when safe and legal to do so. Never program while driving. GPS mapping may not be detailed in all areas or reflect current road status. Connectivity service required. App subscriptions may be required. Data rates may apply. Subject to third party service availability. Should such service providers terminate or restrict service or features, service or features may be suspended or terminated without notice or with no liability to INFINITI or its partners or agents. Google, Google Play and Google Maps are trademarks of Google LLC. For more information, see www.infiniti.com/intouch/legal.

14 Use Hands Free Text Messaging when parked in a safe location. If you must use while driving, monitor traffic conditions and keep both hands on the steering wheel to prevent collisions. Compatible device required. Message and data rates may apply.

15 System may not engage if sensor is obstructed. System does not have the capability to identify individual passengers. Please see Owner's Manual for feature information.

16 The Advanced Climate Control System with Plasmacluster® air purifier helps scrub the air in the vehicle's interior. The system senses exterior odors, suppresses unpleasant interior odors, stops the inflow of external odors and helps keep the cabin smelling fresh, but does not always eliminate odors.

17 Lowering and raising action for Access mode can only be performed when vehicle is at a complete stop and parked. Please see Owner's Manual for full details and information before using.

18 Remote Engine Start to be used only in accordance with laws or rules in effect in your vehicle's location.

19 MyINFINITI App shown for illustrative purposes only. Feature functionality may vary by vehicle model and options. See MyINFINITI Terms and Conditions.

20 Driver-assist and safety features have limitations which affect how they function in certain situations. The driver must never rely exclusively on any vehicle feature to warn about, prevent or lessen the severity of a collision. It is the driver's responsibility to always be in control, monitor the surroundings and safely operate the vehicle. Read your vehicle's Owner's Manual for further information.

21 Consumer activation of INFINITI InTouch Services ProPILOT Assist 2.1 package ("Package") required for ProPILOT Assist 2.1 functionality. Package trial period included with new vehicle purchase. Trial period may be subject to change or termination at any time and without notice. After trial period ends, monthly subscription fee required. See www.infiniti.com/intouch/legal for more subscription information. ProPILOT Assist 2.1 prevent collisions. It is the driver's responsibility to be in control of the vehicle and monitor traffic conditions at all times. Hands-off freeway driving is possible when driving in a single lane, on the condition that the driver remains attentive on the road ahead and is prepared to immediately take manual control of the steering wheel when conditions of the road, traffic, and vehicle require it. System operates only when lane markings are detected. Does not function in all weather, traffic and road conditions. System has limited control capability and the driver may need to steer, brake or accelerate at any time to maintain safety. See Owner's Manual for safety information.

22 Virtual composite 360° view.

23 2026 EPA Fuel Economy Estimates 16 City/20 Highway/18 Combined for QX80 2WD; 16 City/19 Highway/17 Combined for QX80 4WD. Actual mileage may vary with driving conditions. Use for comparison only.

24 Towing capacity varies by configuration. See INFINITI Towing Guide and Owner's Manual for additional information. Always secure cargo.

25 INFINITI All-Mode 4WD® cannot prevent collisions or provide enhanced traction in all conditions. Always monitor traffic and weather conditions.

26 Do not ride in a moving vehicle when the seatback is reclined. For the most effective protection, the seat should be upright. See Owner's Manual for safety information.

27 **INFINITI vehicle with AT&T-compatible in-vehicle Wi-Fi hotspot capability:** 3-GB or 90-Day (whichever occurs first) AT&T in-vehicle Wi-Fi trial subscription ("**AT&T in-vehicle Wi-Fi Hotspot Trial**") is included with the purchase or lease of a new INFINITI vehicle if: (i) vehicle is equipped with compatible SIM, and (ii) customer activates AT&T in-vehicle Wi-Fi Trial ("Trial Activation"). Data charges may apply. Trial period begins at time of customer's Trial Activation. Trial ends when all data is used or period ends, whichever comes first. Trial does not renew. To continue service following expiration of the trial period, purchase of an AT&T subscription is required. **This feature is not intended for use by the driver while the vehicle is in motion. Always drive safely. AT&T in-vehicle Wi-Fi Trial is owned and operated by AT&T, use of AT&T account and its services and features are subject to the AT&T Consumer Service Agreement and Privacy Policy, and are not within Nissan's control. Other restrictions apply. Visit www.att.com/csa for complete terms and conditions.** Should AT&T terminate, change, or restrict service or features, service or features may be suspended or terminated without notice or with no liability to INFINITI or its partners or agents. INFINITI and its partners or agents are also not responsible for associated costs or other third party charges that may be required for continued operation due to cellular network unavailability, restriction, or termination (including equipment replacements/upgrades, if available, or roaming charges on alternative networks). Trial subscription is subject to change or early termination at any time without notice. AT&T, AT&T logo and all other marks contained herein are trademarks of AT&T Intellectual Property and/or AT&T affiliated companies. The INFINITI names, logos and slogans are trademarks owned by or licensed to INFINITI Motor Co. Ltd. and/or its North American subsidiaries. Other trademarks and trade names are those of their respective owners.

28 INFINITI vehicle with "SiriusXM with 360L" capability: SiriusXM with 360L trial period is included with the purchase or lease of a new INFINITI vehicle if: (i) vehicle is equipped with SiriusXM with 360L capability and (ii) vehicle is purchased or leased from new INFINITI dealer stock. Trial period begins on the purchase or lease date of the qualifying new INFINITI vehicle. SiriusXM with 360L is owned and operated by SiriusXM, use of the SiriusXM Customer Agreement and Privacy Policy available at siriusxm.com, and are not within INFINITI's control. Should SiriusXM terminate, change, or restrict service or features, service or features may be suspended or terminated without notice or with no liability to INFINITI or its partners or agents. INFINITI and its partners or agents are also not responsible for associated costs or other third party charges that may be required for continued operation due to cellular network unavailability, restriction, or termination (including equipment replacements/upgrades, if available, or roaming charges on alternative networks). Trial period is subject to change or early termination at any time without notice. SiriusXM and related logos are trademarks of Sirius XM Radio Inc. and its respective subsidiaries.

SiriusXM and SiriusXM with 360L Trial Subscription: Service will automatically stop at the end of your trial subscription period unless you decide to continue service. Trial is non-transferable. If you do not wish to enjoy your trial, you can cancel by calling the number below. All SiriusXM services require a subscription, each sold separately by SiriusXM after the trial period. **Service subject to the SiriusXM Customer Agreement and Privacy Policy, visit siriusxm.com for complete terms and how to cancel which includes online methods or calling 1-866-635-2349.** Some services and features are subject to device capabilities and location availability. Satellite service not available in AK & HI. Certain features and/or content may not be available in vehicles with SiriusXM with 360L unless an active data connection is enabled in the vehicle. Content varies by SiriusXM subscription package. All fees, content and features are subject to change.

29 Air bags are only a supplemental restraint system. Always wear your seat belt. Rear-facing child restraints should not be placed in the front-passenger's seat. All children 12 and under should ride in the rear seat properly secured in child restraints, booster seats or seat belts according to their size. Air bags will only inflate in certain accidents. See Owner's Manual for safety information.

30 Tire Pressure Monitoring System is not a substitute for regular tire pressure checks. See Owner's Manual for safety information.

31 Vehicle must be on for the Easy-Fill Tire Alert to operate.

32 Do not perform slide forward function with the Child Restraint System occupied.

33 120-volt power outlet is intended only for use with compatible items. Please check specifications of wattage and amperage of items to be plugged in to determine compatibility.

34 Accessories shown on vehicle are not genuine INFINITI parts/accessories. Not warranted by INFINITI. Refer to product manufacturer for warranty details. INFINITI limited warranty does not cover damages or failures to the vehicle caused by improper installation or alterations of any accessory or component. Contact your retailer for details.

35 INFINITI Premium Care oil/tire maintenance provided through Elite Protection Program is included with the purchase/lease of a new 2026 INFINITI vehicle from retailer stock. Certain restrictions apply. **In Florida (License #60128), Missouri, North Dakota and Oregon, INFINITI Extended Services North America is backed by Nissan Extended Services North America, Inc., P.O. Box 685004, Franklin, TN 37068-5004.** Replacement of any part will be made with a new Genuine INFINITI or INFINITI-approved replacement part in use at the time of repair. The replacement part may differ from the original.

Apple CarPlay®, CarPlay® and Lightning® are registered trademarks of Apple Inc. iPhone® is a registered trademark of Apple Inc. All rights reserved. iPhone® or other external device not included. Pairing speed may vary when establishing CarPlay connection wirelessly. Wireless smartphone integration only supported with CarPlay. Bluetooth® word mark and logos are owned by Bluetooth SIG, Inc., and any use of such marks by INFINITI is under license. DJX® is a registered trademark of the Panasonic Corporation. DynamicAudioReveal® is a registered trademark of the Panasonic Corporation. Facebook® is a registered trademark of Meta Platforms, Inc. Google, Android Auto, Google Maps, YouTube Music and other marks are trademarks of Google LLC. Compatible Android phone and compatible active data plan required. To wirelessly use Android Auto on your car display, you need a compatible Android smartphone with an active data plan. You can check which smartphones are compatible at g.co/androidauto/requirements. HomeLink® is a registered trademark of Genex Corporation. Instagram® is a registered trademark of Instagram, LLC. Klipsch® is a registered trademark of Klipsch Group, Inc. myQ® is a registered trademark of The Chamberlain Group, Inc. Plasmacluster® is a registered trademark of the Sharp Corporation. SiriusXM is a registered trademark of Sirius XM Radio Inc. X is a trademark of X Corp. Yakima® is a registered trademark of Yakima Products, Inc.

This brochure is intended for general descriptive and informational purposes only. It is subject to change and does not constitute an offer, representation or warranty (express or implied) by Nissan North America, Inc. Interested parties should confirm the accuracy of any information in this brochure as it relates to a vehicle directly with Nissan North America, Inc. before relying on it to make a purchase decision. Nissan North America, Inc. reserves the right to make changes, at any time, without prior notice, in prices, colors, materials, equipment, specifications, and models and to discontinue models or equipment. Due to continuous product development and other pre- and post-production factors, actual vehicle, materials and specifications may vary from this brochure. Some vehicles shown with optional equipment. See the actual vehicle for complete accuracy. Availability and delivery times for particular models or equipment may vary. Specifications, options and accessories may differ in Hawaii, U.S. territories and other countries. For additional information on availability, options or accessories, contact your INFINITI retailer or Nissan North America, Inc.